

# STEP-BY-STEP GUIDE FOR INSTALLING CHAMELEON SP-IN-X-X

**READ AND FOLLOW ALL SAFETY INSTRUCTIONS!**  
**SAVE THESE INSTRUCTIONS AND DELIVER TO OWNER AFTER INSTALLATION**

- To reduce the risk of death, personal injury or property damage from fire, electric shock, falling parts, cuts/abrasions, and other hazards please read all warnings and instructions included with and on the fixture box and all fixture labels.
- Before installing, servicing, or performing routine maintenance upon this equipment, follow these general precautions.
- Installation and service of luminaires should be performed by a **qualified licensed electrician**.
- Maintenance of the luminaires should be performed by person(s) familiar with the luminaires' construction and operation and any hazards involved. Regular fixture maintenance programs are recommended.
- It will occasionally be necessary to clean the outside of the refractor/lens. Frequency of cleaning will depend on ambient dirt level and minimum light output which is acceptable to user. Refractor/lens should be washed in a solution of warm water and any mild, non-abrasive household detergent, rinsed with clean water and wiped dry. Should optical assembly become dirty on the inside, wipe refractor/lens and clean in above manner, replacing damaged gaskets as necessary.
- **DO NOT INSTALL DAMAGED PRODUCT!** This luminaire has been properly packed so that no parts should have been damaged during transit. Inspect to confirm. Any part damaged or broken during or after assembly should be replaced.
- Recycle: For information on how to recycle LED electronic products, please visit [www.epa.gov](http://www.epa.gov).



**WARNING**  
**RISK OF ELECTRIC SHOCK**

- ✓ Disconnect or turn off power before installation or servicing.
- ✓ Verify that supply voltage is correct by comparing it with the luminaire label information.
- ✓ Make all electrical and grounded connections in accordance with the National Electrical Code (NEC) and any applicable local code requirements.
- ✓ All wiring connections should be capped with UL approved recognized wire connectors.



**WARNING**  
**RISK OF BURN**

- ✓ Allow lamp/fixture to cool before handling. Do not touch enclosure or light source.
- ✓ Do not exceed maximum wattage marked on luminaire label.
- ✓ Follow all manufacturer's warnings, recommendations and restrictions for: driver type, burning position, mounting locations/methods, replacement and recycling.



**CAUTION**  
**RISK OF INJURY**

- ✓ Wear gloves and safety glasses at all times when removing luminaire from carton, installing, servicing or performing maintenance.
- ✓ Avoid direct eye exposure to the light source while it is on.



**CAUTION**  
**RISK OF FIRE**

- ✓ Keep combustible and other materials that can burn, away from lamp/lens.
- ✓ Do not operate in close proximity to persons, combustible materials or substances affected by heat or drying.

- ✓ Never connect components under load.
- ✓ Do not mount or support these fixtures in a manner that can cut the outer jacket or damage wire insulation.
- ✓ Controls for dimming, auto-sensing, or remote control of a luminaire that are not factory-wired to the luminaire must be checked for compatibility with the luminaire prior to installation. LED fixtures must be powered directly off a switched circuit.
- ✓ Unless individual product specifications deem otherwise: Do not restrict fixture ventilation. Allow for some volume of airspace around fixture. Avoid covering LED fixtures with insulation, foam, or other material that will prevent convection or conduction cooling.
- ✓ Unless individual product specifications deem otherwise: Do not exceed fixtures maximum ambient temperature.
- ✓ Only use fixture in its intended location.
- ✓ LED products are Polarity Sensitive. Ensure proper Polarity before installation.
- ✓ Electrostatic Discharge (ESD): ESD can damage LED fixtures. Personal grounding equipment must be worn during all installation or servicing of the unit.
- ✓ Do not touch individual electrical components as this can cause ESD, shorten lamp life, or alter performance.
- ✓ Some components inside the fixture may not be serviceable. In the unlikely event your unit may require service, stop using the unit immediately and contact an Chameleon Lighting representative for assistance.
- ✓ Always read the fixtures complete installation instructions prior to installation for any additional fixture specific warnings.
- ✓ Always ensure that the electrical distribution system is up to NEC (and any applicable local code) requirements.
- ✓ Verify that power distribution system has proper grounding. Lack of proper earth ground can lead to fixture failure and may void warranty.



## INSTALLATION INSTRUCTIONS FOR FIXTURE: P53 PASSIVE P5-L3/P5-L6

**WARNING:** Risk of fire and electric shock! This fixture must be installed by a qualified electrician only! MAKE SURE ELECTRICAL CURRENT IS DISCONNECTED BEFORE MAKING ELECTRICAL SPLICES

### DISCONNECT POWER

1. UNWRAP ALL FIXTURE COMPONENTS INCLUDING PARTS BAG
2. REMOVE CAP NUTS FROM CYLINDER
3. REMOVE DRIVER ASSEMBLY FROM CYLINDER  
ATTACH DRIVER ASSEMBLY TOP PLATE TO ELECTRICAL ENCLOSURE (BY OTHERS) WITH TWO SCREWS (NOTE PROVIDED)
5. CONNECT WHITE DRIVER ASSEMBLY LEAD TO WHITE SUPPLY WIRE. BLACK DRIVER ASSEMBLY LEAD TO BLACK SUPPLY LEAD (CONNECTORS NOT PROVIDED)
6. ATTACH SUPPLY GROUND TO GROUND SCREW ON TOP OF DRIVER ASSEMBLY TOP PLATE
7. INSERT DRIVER ASSEMBLY INTO CYLINDER AND SECURE WITH TWO CAP NUTS
8. INSTALL OPTICAL REFLECTOR, CAREFULLY ALIGN SLOTS ON REFLECTOR AND TEETH ON COB HOLDER, TWIST AND LOCK IN PLACE
9. ADJUST POWER CORD TO REQUIRED LENGTH (20FT STANDARD). ADJUST ONLY ON BOTTOM OF CYLINDER. MINIMUM CORD LENGTH IS 18 INCHES.

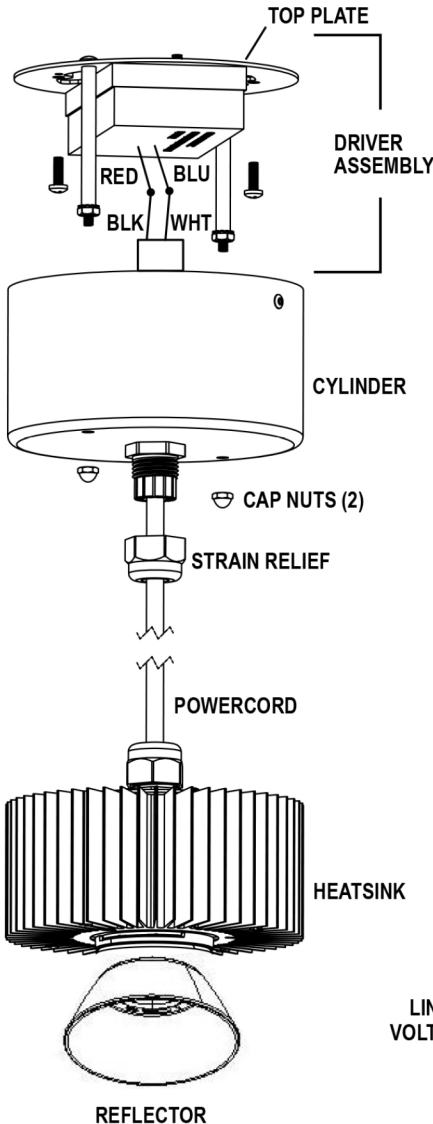

IMPORTANT: Cap OFF all unused LEADS.  
 ORG lead is for programming only.  
 PUR(+) & GRY(-) leads are for 0-10V dimming only.  
 FAILURE to install MOV surge protector voids Driver & Fixture warranty.  
 SEE MANUFACTURER'S MOV INCLUDED INSTRUCTIONS.

**CLEANING AND DIODE CARE:** ANY DUST OR DEBRIS ON THE YELLOW PHOSPHOR RESIN AREA OF THE LED DIODE MAY ADVERSLY AFFECT DIODE PERFORMANCE AND SHORTEN THE LIFE OF THE DIODE. ANY DUST AND DEBRIS MUST BE CLEANED PRIOR TO TURNING THE DIODE ON BY GENTLY RINSING IT WITH ISOPROPYL ALCOHOL (COMMONLY CALLED RUBBING ALCOHOL) ON A Q-TIP. AVOID APPLYING PRESSURE TO THE YELLOW PHOSPHOR RESIN AREA. CONTACT MAY CAUSE DAMAGE TO THE LED ARRAY AND WILL VOID ANY MANUFACTURERS WARRENTY.

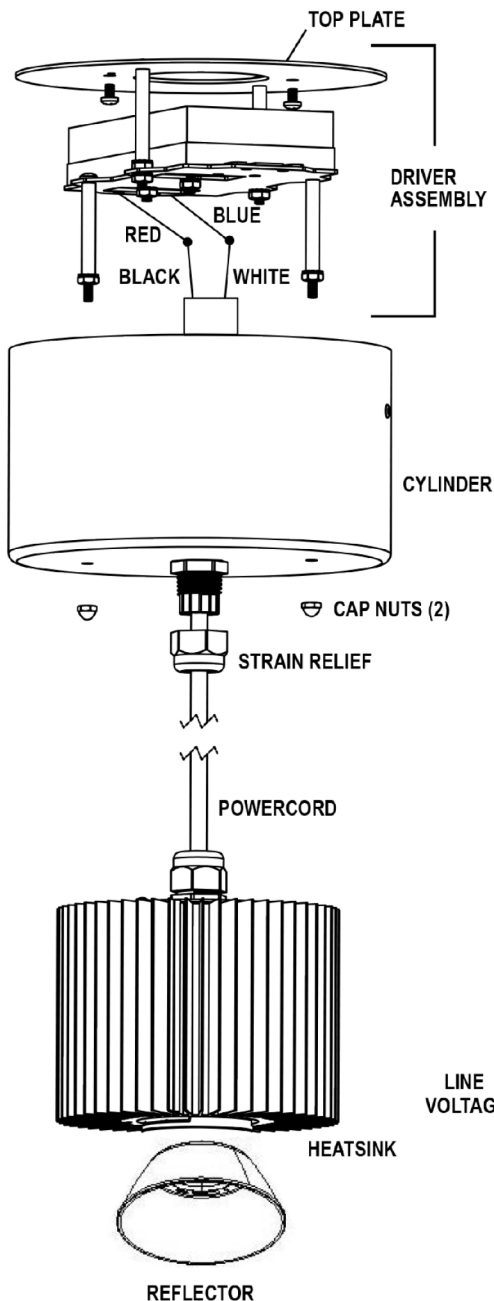

**INSTALLATION INSTRUCTIONS FOR FIXTURE: P59, P56 PASSIVE  
P5-L8/P5-L12**

**WARNING:** Risk of fire and electric shock! This fixture must be installed by a qualified electrician only! MAKE SURE ELECTRICAL CURRENT IS DISCONNECTED BEFORE MAKING ELECTRICAL SPLICES

**DISCONNECT POWER**

1. UNWRAP ALL FIXTURE COMPONENTS INCLUDING PARTS BAG
2. REMOVE CAP NUTS FROM CYLINDER
3. REMOVE DRIVER ASSEMBLY FROM CYLINDER  
ATTACH DRIVER ASSEMBLY TOP PLATE TO ELECTRICAL ENCLOSURE (BY OTHERS) WITH TWO SCREWS (NOTE PROVIDED)
4. CONNECT WHITE DRIVER ASSEMBLY LEAD TO WHITE SUPPLY WIRE. BLACK DRIVER ASSEMBLY LEAD TO BLACK SUPPLY LEAD (CONNECTORS NOT PROVIDED)
5. ATTACH SUPPLY GROUND TO GROUND SCREW ON TOP OF DRIVER ASSEMBLY TOP PLATE
6. INSERT DRIVER ASSEMBLY INTO CYLINDER AND SECURE WITH TWO CAP NUTS
7. INSTALL OPTICAL REFLECTOR, CAREFULLY ALIGN SLOTS ON REFLECTOR AND TEETH ON COB HOLDER, TWIST AND LOCK IN PLACE
8. ADJUST POWER CORD TO REQUIRED LENGTH (20FT STANDARD). ADJUST ONLY ON BOTTOM OF CYLINDER. MINIMUM CORD LENGTH IS 18 INCHES.



IMPORTANT: Cap OFF all unused LEADS.  
 ORG lead is for programming only.  
 PUR(+) & GRY(-) leads are for 0-10V dimming only.  
 FAILURE to install MOV surge protector voids Driver & Fixture warranty.  
 SEE MANUFACTURER'S MOV INCLUDED INSTRUCTIONS.

**CLEANING AND DIODE CARE:** ANY DUST OR DEBRIS ON THE YELLOW PHOSPHOR RESIN AREA OF THE LED DIODE MAY ADVERSLY AFFECT DIODE PERFORMANCE AND SHORTEN THE LIFE OF THE DIODE. ANY DUST AND DEBRIS MUST BE CLEANED PRIOR TO TURNING THE DIODE ON BY GENTLY RINSING IT WITH ISOPROPYL ALCOHOL (COMMONLY CALLED RUBBING ALCOHOL) ON A Q-TIP. AVOID APPLYING PRESSURE TO THE YELLOW PHOSPHOR RESIN AREA. CONTACT MAY CAUSE DAMAGE TO THE LED ARRAY AND WILL VOID ANY MANUFACTURERS WARRENTY.

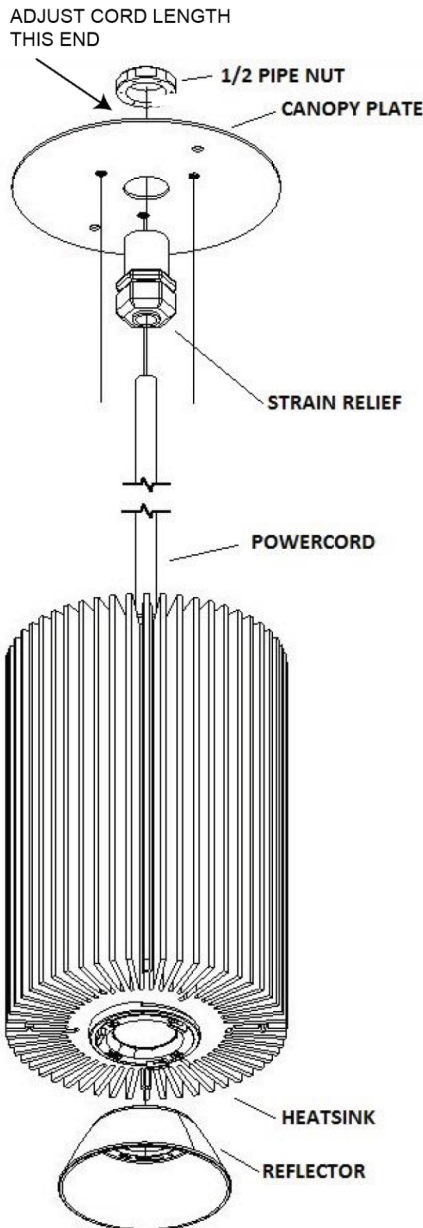

INSTALLATION INSTRUCTIONS FOR FIXTURE: P59 PASSIVE  
P5-L15/P5-L18

**WARNING:** Risk of fire and electric shock! This fixture must be installed by a qualified electrician only! CONFIRM ELECTRICAL CURRENT IS OFF BEFORE MAKING ELECTRICAL CONNECTIONS

1. UNWRAP ALL FIXTURE COMPONENTS INCLUDING PARTS BAG
2. FEED SUSPENSION CORD THROUGH STRAIN RELIEF ON CANOPY PLATE, ADJUST TO REQUIRED LENGTH (20 FT STANDARD) ADJUST ONLY ON END WITH CANOPY PLATE, AND TIGHTEN STRAIN RELIEF NUT UNTIL BOTTOMS OUT. **18" CORD LENGTH MINIMUM FOR THE LOW VOLTAGE LUMINAIRE.**
3. INSTALL REMOTE DRIVER INTO THE ELECTRICAL ENCLOSURE AS NECESSARY (BY OTHERS). **POWER UNIT: MINIMUM IS 6' FROM THE FIXTURE**
4. PERFORM ELECTRICAL CONNECTION OF REMOTE DRIVER TO FIXTURE POWERCORD:  
CONNECT RED(+) WIRE FROM DRIVER TO BLACK(+) WIRE FROM FIXTURE CORD, BLUE (-)WIRE FROM DRIVER TO WHITE(-) WIRE FROM FIXTURE CORD, AND GREEN GROUND WIRE FROM FIXTURE CORD TO GROUND WIRE FROM DRIVER & POWER WHIP (BY OTHERS)
5. PERFORM ELECTRICAL CONNECTION OF REMOTE DRIVER TO J-BOX: CONNECT BLACK TO BLACK, WHITE TO WHITE, AND GROUND TO GREEN.
6. MOUNT CANOPY PLATE TO 4" OCTOGON J-BOX BY OTHERS.
7. INSTALL OPTICAL REFLECTOR, CAREFULLY ALIGN SLOTS ON REFLECTOR AND TEETH ON COB HOLDER, TWIST AND LOCK IN PLACE.

WIRING DIAGRAM

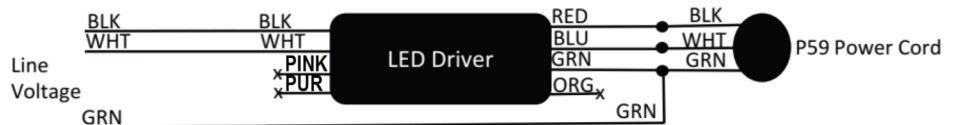

IMPORTANT: Cap OFF all unused LEADS.  
ORG lead is for programming only.  
PINK(-) & PURPLE(+) leads are for 0-10V dimming only.  
FAILURE to install MOV surge protector voids Driver & Fixture warranty.  
SEE MANUFACTURER'S MOV INCLUDED INSTRUCTIONS.

**CLEANING AND COB CARE:** ANY DUST OR DEBRIS ON THE YELLOW PHOSPHOR RESIN AREA OF THE LED COB MAY ADVERSELY AFFECT COB PERFORMANCE AND SHORTEN THE LIFE OF THE COB. ANY ACCUMULATED DUST AND DEBRIS MUST BE CLEANED PRIOR TO POWERING UP THE FIXTURE BY GENTLY APPLYING ISOPROPYL ALCOHOL (COMMONLY CALLED RUBBING ALCOHOL) WITH A Q-TIP. AVOID APPLYING DIRECT PRESSURE TO THE YELLOW PHOSPHOROUS AREA. CONTACT MAY CAUSE DAMAGE TO THE COB AND WILL VOID MANUFACTURERS WARRANTY.

8/32 SCREW



## INSTALLATION INSTRUCTIONS FOR SP-CN-X-O

**WARNING: Risk of fire and electrical shock! This fixture must be installed by a qualified electrician only! MAKE SURE ELECTRICAL CURRENT IS DISCONNECTED BEFORE KIT INSTALLATION**

### DISCONNECT POWER

1. UNWRAP ALL FIXTURE COMPONENTS INCLUDING SMALL PARTS BAG ENCLOSED

### PARTS LIST:

- (3) M3 X 12 MM SCREWS
- (1) CLADDING KIT SPREADER
- (1) TYPE CN SPINNING
- (3) 8/32 SCREW AND NUT

2. RAISE TYPE CN SPINNING OVER P5 FIXTURE AND HOLD.

3. SLIP THE CLADDING KIT SPREADER AROUND THE POWERCORD AND PLACE ON TOP OF THE P5 TYPE CN CONVERSION PLATE.

4. SECURE CLADDING KIT SPREADER TO TYPE CN SPINNING USING (3) CABLE PADS

5. SECURE CLADDING KIT SPREADER TO P5 TYPE CN CONVERSION PLATE USING (3) M3 X 12 MM SCREWS INTO TOP OF P5X FIXTURE.

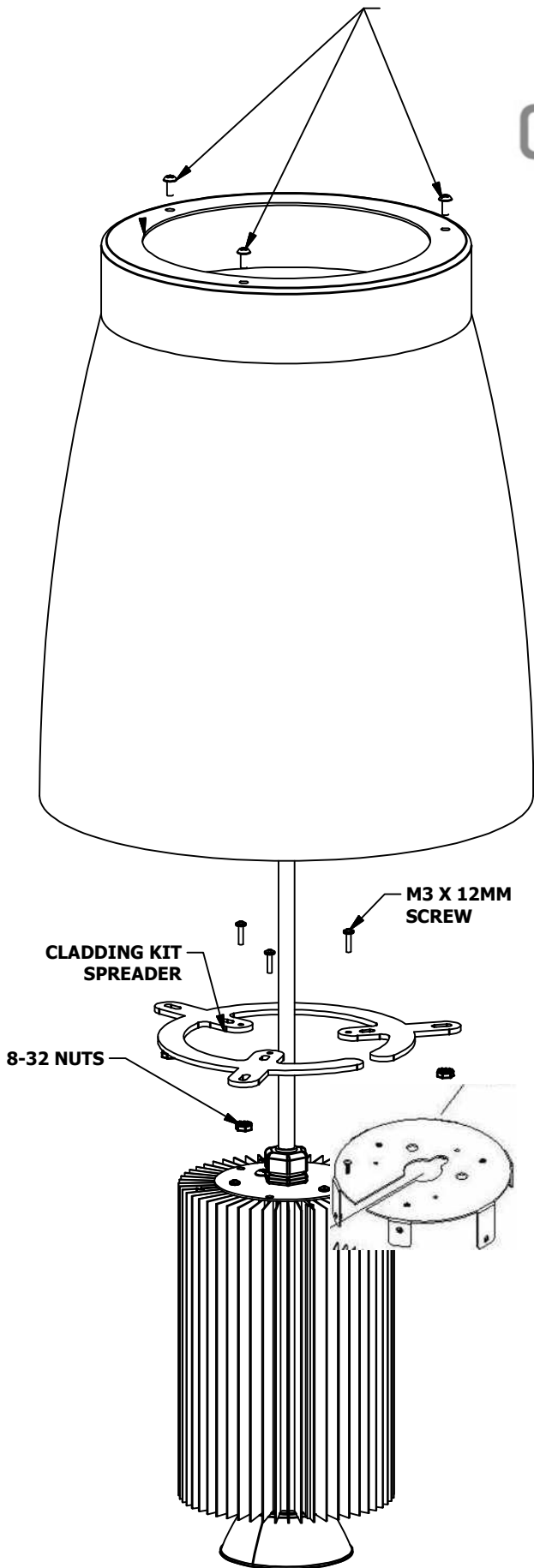

243 Chesterfield Industrial Blvd Chesterfield, MO 63005

888-896-2101

[www.ChameleonLTG.com](http://www.ChameleonLTG.com)